

AWP20S

Specification

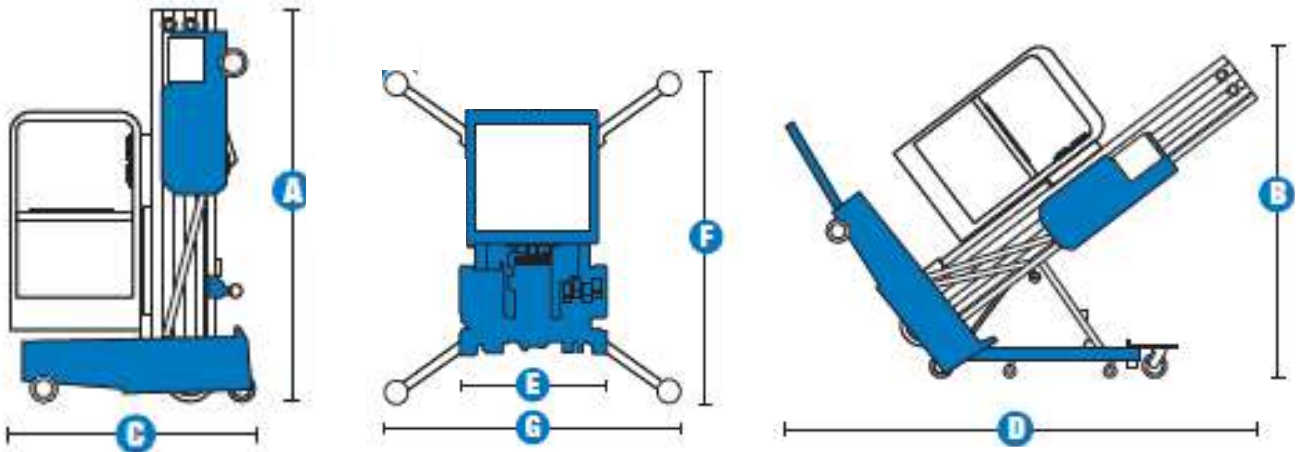

Specification	AWP20S
Platform height	6.12 m.
Working height	8.12 m.
Height-Stowed [A]	1.98 m.
Tiled back [B]	-
Length stowed [C]	1.24 m.
Length [D]	-
Width [E]	0.74 m.
Outrigger footprint [F/G]	1.55/1.35 m.
Lift capacity	159 kg.
Machine weight	307 kg.
Power source	AC 220V.

